

Product Name

Brixia L

Technical description

Body and pole connection in die-cast aluminum alloy UNI EN 1706 (Low copper content), double painting with polyester powder resistant to the salt fog. Stainless steel screws AISI 304. Tempered sodium-calcic glass, 5 mm thick. Guaranteed 91% transparency. Expanded silicone gaskets. LED light source, colour temperature (4000 K Neutral White). High coefficient of performance chromatic CRI≥70. PCO optics.

Supply

The driver used offers the best performance, reliability and configuration options in road areas. Available on request Dimmer and DALI version. Voltage 220-240 VAC 50 / 60Hz. Operating temperature -40°+50° Surge protection device: Integrated SPD, 10kV-10kA

Installation

Can be installed with a pole-top or lateral mounting, from 42 mm to 60 mm diameter pole. Inclination Pole head 0° - 5° - 10° - 15° - 20°.

Control System

- ON-OFF:** fixed non-dimmable
- MV:** Automatic dimming (virtual midnight) with default profile
- CLO:** constant luminous flux
- DALI:** DALI 2 digital dimmer interface
- DI:** 1-10V analogue dimmer interface
- NEMA:** possibility to apply NEMA IP66 connector
- ZHAGA:** possibility to apply ZHAGA connector

Life

≥100.000 hr L90B10 / ≥ 110.000hr TM21-L70

Applications

Car parks, street, pedestrian areas

Size (mm)

634x246x225

Colour

Dark grey 4

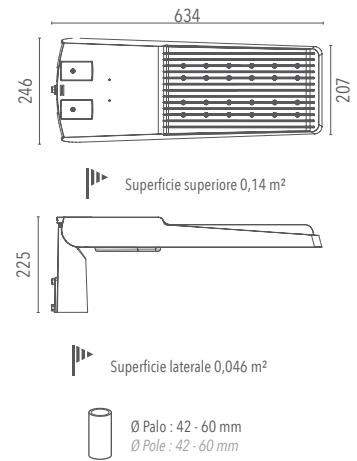

Secondary and urban suburban roads - historic centers

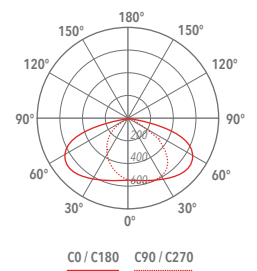

Code	Source	Power	Lm (Output)	Lm (Tc=25°)	Temperature	CRI	Beams	Colour	Control
LOBXL4AH2BL40180	LED	180 W	26928 lm	31680 lm	4000 K	≥70	H2	Dark grey	-
LOBXL4AH2DI40180	LED	180 W	26928 lm	31680 lm	4000 K	≥70	H2	Dark grey	Dimmer
LOBXL4AH2DA40180	LED	180 W	26928 lm	31680 lm	4000 K	≥70	H2	Dark grey	DALI

Accessories



Lanzini indicates the luminous flux of the luminaire in the catalogs with a tolerance of ± 10% respect to the indicated value. The total W indicates the total power absorbed by the LED + power supply system that does not exceed 10% of the indicated value.