

Product Name

GT

(Integrated driver)

Technical description

GT is a Led appliance designed and built to be the ideal lighting solution for tunnel and underpasses where high performance is required. Lower body in die-cast aluminum alloy UNI EN 1706 (Low copper content), double painting with polyester powder resistant to the salt fog. Upper body in extruded aluminum, anodised. Screws made of AISI 304 stainless steel. Tempered glass sodium-calcium type, 5 mm thickness, 91% transparency is guaranteed. Silicone gaskets. LED light source (lumileds), colour temperature (4000 K Neutral White). High coefficient of performance chromatic CRI≥70-80. Optic optical PC.

Supply

Integrated driver, DALI communication, External NTC interface temperature control
 Input voltage 220 - 240 V AC 50/60 Hz.
 Temperature -40° +45°

Installation

Wall and ceiling

Applications

Tunnel, Underpasses

Size (mm)

389 x 355 x 239

Colour

Dark grey **4**

Decay of the luminous flux

≥100.000 hr L80B20

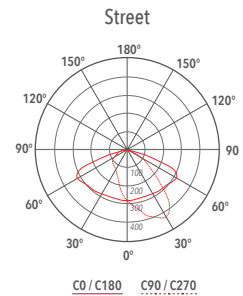
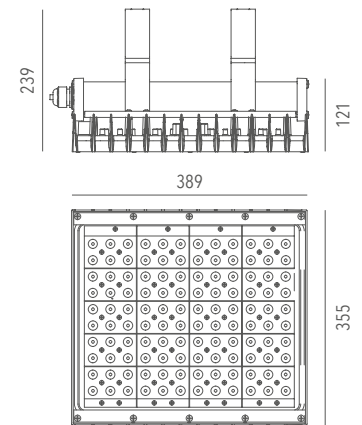

Code	Source	Power	Lm (Output)	Lm (Tc=25°)	Temperature	CRI	Beams	Colour	Control
L00GT40H4DA40160	LED	160 W	21600 lm	26080 lm	4000 K	≥70-80	H4	Dark grey	DALI

Accessories



Connection kit for slotted cable trays 100 mm
 LKITA00000000010



Connection kit for slotted cable trays 200 mm
 LKITA00000000011



Connection kit for slotted cable trays 300 mm
 LKITA00000000012

LANZINI indicates the luminous flux of the luminaire in the catalogs with a tolerance of ± 10% respect to the indicated value. The total W indicates the total power absorbed by the LED + power supply system that does not exceed 10% of the indicated value.